

MINICOMPACT

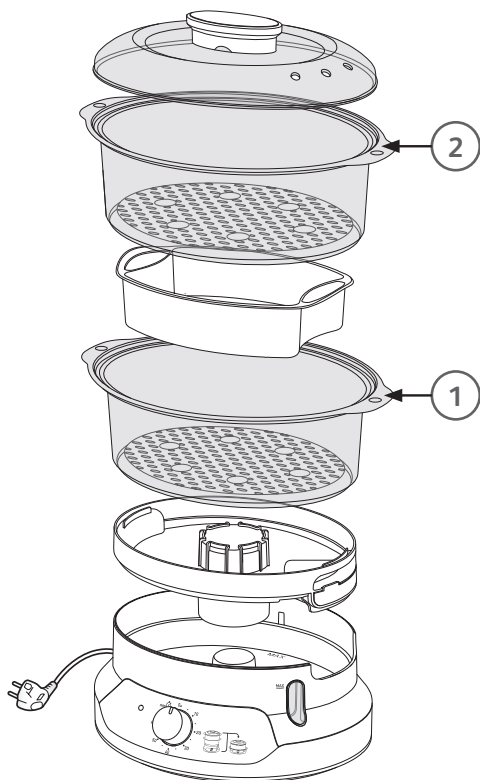

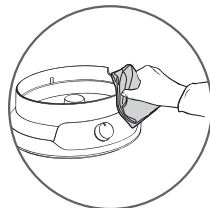

1

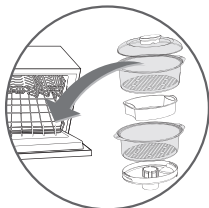
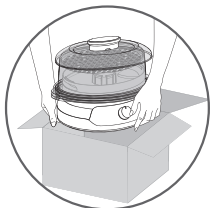
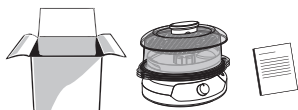

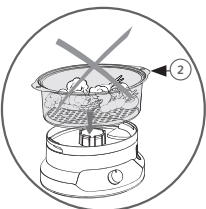
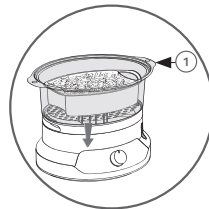
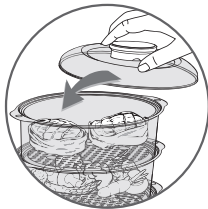
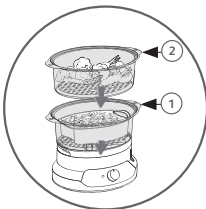
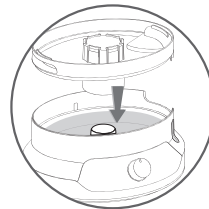
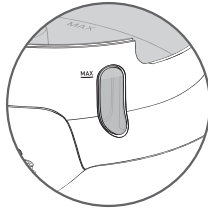
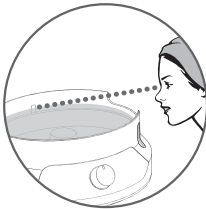
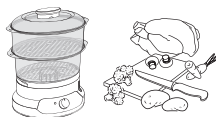

3

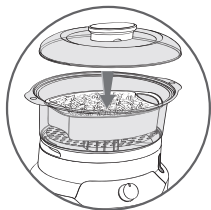
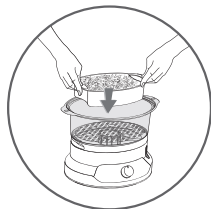

4

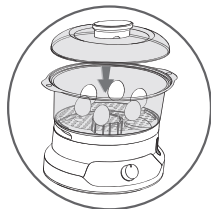

* eau - water - wasser - water - acqua - agua - aqua - νερό - su - vand - vatten - vann -
vettä - вода - voda - víz - voda - voda - voda - вода - ара - voda - الماء



5

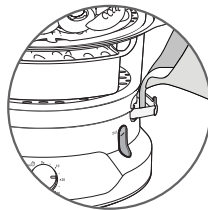
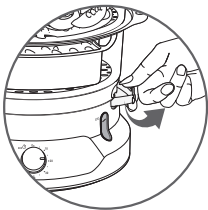
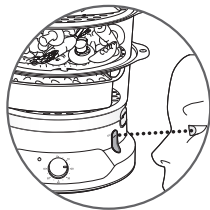
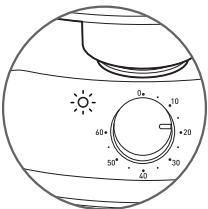
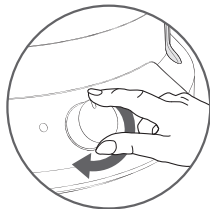
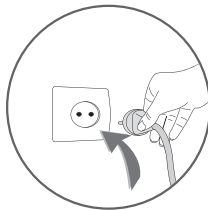
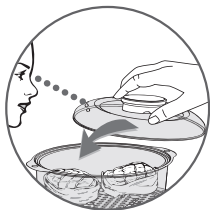

6

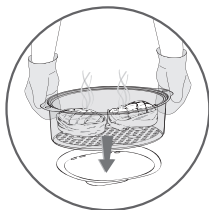
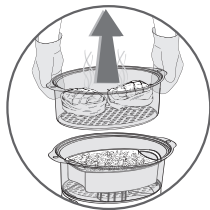
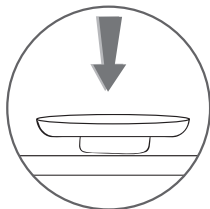
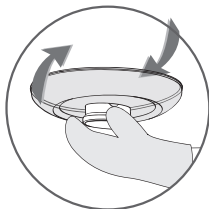
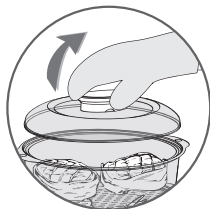
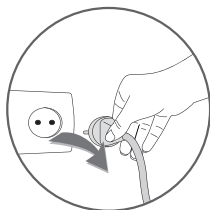
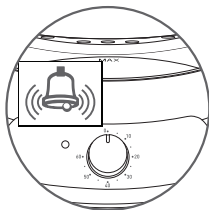

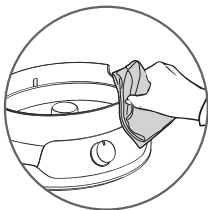
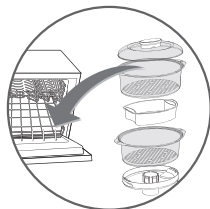
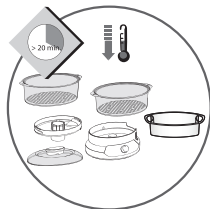

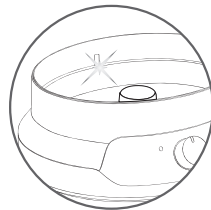
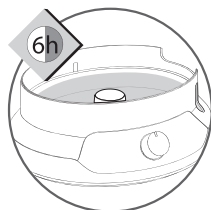
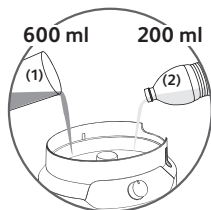





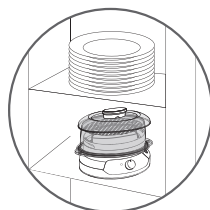
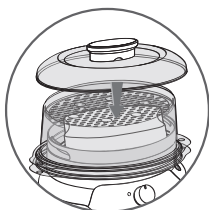
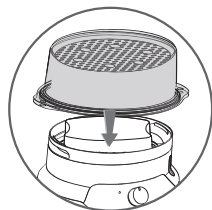
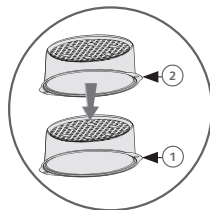
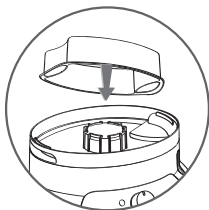
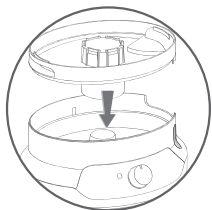
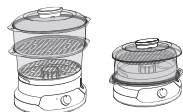

























(1) * eau - water - wasser - water - acqua - agua - agua - νερό -
su - vand - vatten - vann - vettä - вода - voda - víz - voda - voda -
voda - apa - вода - voda - الماء

(2) ** vinaigre - vinegar - essig - azijn - aceto - vinagre - vinagre
- Ξίδι - sirke - eddike - vinäger - eddik - etikkaa - уксус - kis - ecet -
ocot - ocet - vinný ocet - otet - оцет - ocat - الخل





			
		200 g	20 - 30 min
	 ***	200 g	20 - 30 min
		200/300 g	20 - 30 min
		200 g	20 - 30 min
		6	20 - 30 min
	 	150 g +	30 - 40 min
		300 g	30 - 40 min
	 ***	300 g	40 - 50 min
		150 g	20 - 30 min
		300 g	50 - 60 min
		150 g	30 - 40 min
		300 g	50 - 60 min
	 ***	300 g	40 - 50 min
		300 g	30 - 40 min
		300 g	40 - 50 min
	 ***	300 g	50 - 60 min
		300 g	30 - 40 min
		300 g	30 - 40 min
		300 g	30 - 40 min
	300 g	30 - 40 min	
		4	40 - 50 min
		4	30 - 40 min

* eau - water - wasser - water - acqua - agua - agua - нeпö - su - vand - vatten - vann - vettä - вода - voda - víz - voda - woda - voda - apa - вода - voda - الماء

Ref : 1820005980